



CERTIFIED

# RADICAL

UNDERFLOOR HEATING  
PRODUCT AND TECHNICAL GUIDE



PIPE AND FLOOR SYSTEMS

MANIFOLDS AND PUMPS

CONTROLS AND COMPONENTS

PRESS FIT

ELECTRIC UFH

HEAT PUMPS

We are an MCS accredited leading supplier of underfloor heating and renewable energy products nationwide. Based in Lancashire since 2011, our priority is to provide the highest quality products for the best possible price.

### Nationwide Service

We distribute all our products nationally in the UK on a next day basis so you do not need to hold any stock for your own customers. We hold extensive stock profiles of all our ranges for you to call on at a moment's notice.



### Technical Support

Our vastly experienced technical team is on hand to advise and assist with any of your projects. We are available to support you from concept to installation in every aspect of your projects.



### System Design

Design engineers produce detailed CAD designs for your installations, all of which are underwritten by Professional Indemnity insurance giving you expert support and total peace of mind.



### Specialist Services

Our specialist installation teams are available to assist with bespoke installations across the UK ensuring you have total peace of mind with our experts working with you on your projects when necessary.

|                      |    |
|----------------------|----|
| PIPE SPECIFICATIONS  | 4  |
| SCREEDED SYSTEMS     | 6  |
| OVERLAY SYSTEMS      | 8  |
| JOISTED SYSTEMS      | 10 |
| MANIFOLDS AND PUMPS  | 12 |
| CONTROLS             | 14 |
| COMPONENTS AND TOOLS | 16 |
| PRESS FIT            | 18 |
| ELECTRIC UFH         | 20 |
| HEAT PUMPS           | 21 |



With lower system temperatures, make your home more energy efficient. Our systems are also perfect for use with renewable energy sources.



The dryness of the heat produced deprives bacteria and dust mites of moisture they need for survival. In contrast, radiators and the convection currents they create propel dust and mites around your home potentially causing irritation.



We are so confident in our product offering that we offer warranties upto 50 years.



Energy efficiency, luxury feeling and cost savings on heating bills are a great selling point for homes with UFH.

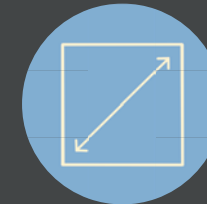

The entire living space can be utilised, as wall spaces are free of radiators and any cold spots are eliminated, as the whole floor emits heat into the room.



Comfortable and even temperatures across your heated rooms with no cold spots.

# PIPE SPECIFICATIONS



## PE-RT PIPE

### 3 Layer PE-RT

| SIZE                | CODE      |
|---------------------|-----------|
| 80m x 12mm x 1.6mm  | RHS83-009 |
| 320m x 12mm x 1.6mm | RHS83-001 |

### 5 Layer PE-RT

| SIZE              | CODE      |
|-------------------|-----------|
| 100m x 12mm x 2mm | RHS20-001 |
| 240m x 12mm x 2mm | RHS20-002 |
| 100m x 16mm x 2mm | RHS83-008 |
| 240m x 16mm x 2mm | RHS83-007 |
| 400m x 16mm x 2mm | RHS83-006 |

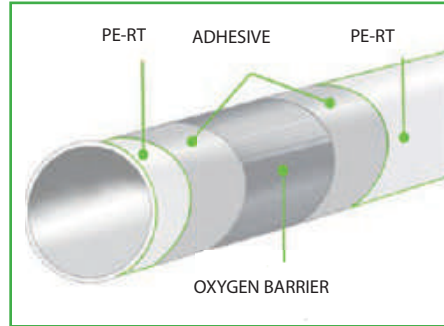
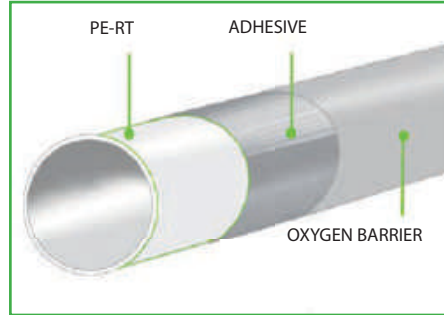

## PRE INSULATED MLCP

Insulation is 7mm thick and made of polyethylene foam with closed cell material structure. The combined assembly of the pipe, insulation and PE-LD foil achieves a fire class rating of E according to BS- EN13501-1.

| SIZE               | COLOUR | CODE      |
|--------------------|--------|-----------|
| 100m x 16mm x 2mm  | Red    | RHS86-001 |
| 100m x 16mm x 2mm  | Blue   | RHS86-002 |
| 50m x 20mm x 2.0mm | Red    | RHS86-003 |
| 50m x 20mm x 2.0mm | Blue   | RHS86-004 |
| 50m x 25mm x 2.5mm | Red    | RHS86-005 |
| 50m x 25mm x 2.5mm | Blue   | RHS86-006 |
| 50m x 32mm x 3.0mm | Red    | RHS86-007 |
| 50m x 32mm x 3.0mm | Blue   | RHS86-008 |

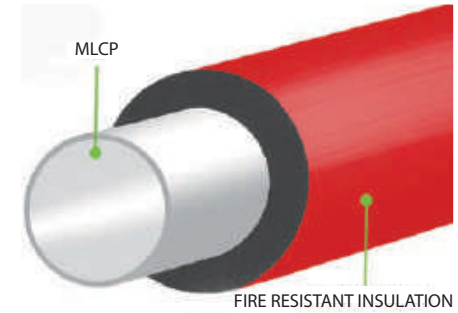

### KEY FEATURES:

- Colour coded flow and returns.
- Insulated to prevent heat loss and freezing.

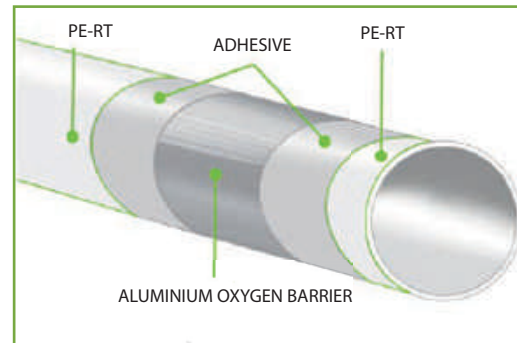

## MLCP

### Multilayer Composite Pipe

| SIZE                | CODE      |
|---------------------|-----------|
| 80m x 12mm x 1.6mm  | RHS82-007 |
| 160m x 12mm x 1.6mm | RHS82-008 |
| 240m x 12mm x 1.6mm | RHS82-009 |
| 50m x 16mm x 2mm    | RHS82-005 |
| 80m x 16mm x 2mm    | RHS82-004 |
| 100m x 16mm x 2mm   | RHS82-001 |
| 200m x 16mm x 2mm   | RHS82-002 |
| 300m x 16mm x 2mm   | RHS82-006 |
| 500m x 16mm x 2mm   | RHS82-003 |
| 50m x 20mm x 2.0mm  | RHS82-010 |
| 50m x 25mm x 2.5mm  | RHS82-011 |
| 50m x 32mm x 3.0mm  | RHS82-012 |



## PIPE ACCESSORIES

| PRODUCT                                   | CODE      |
|---|-----------|
| Small Pipe Cutter 14-32mm                 | RHS55-004 |
| Large PVC/PPR Pipe Cutter 42mm            | RHS55-005 |
| Chamfering device for 16mm MLCP           | RHS55-008 |
| Small Star Reamer 12/16/20mm              | RHS55-006 |
| Large Star Reamer 16/20/25mm              | RHS55-007 |
| Electric Hydraulic Clamp Set for Pressfit | RHS55-003 |



SCAN HERE

TO SEE DATA SHEETS  
FOR PIPE  
ON THIS PAGE



# SCREEDED SYSTEMS

## CLIPS AND CLIP RAIL

### TYPICAL FLOOR PROFILE

#### CLIPS

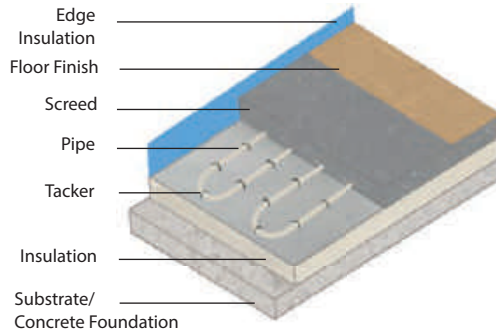

#### CLIP RAIL

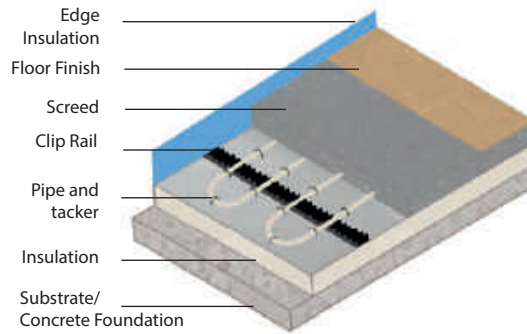

| PRODUCT                 | CODE      |
|-------------------------|-----------|
| 43mm tacker clips       | RHS54-007 |
| 60mm tacker clips       | RHS54-006 |
| Self adhesive clip rail | RHS54-003 |
| Barbed clip rail        | RHS54-004 |
| Standard tacker gun     | RHS55-002 |
| Foldable decoiler       | RHS55-001 |



#### KEY FEATURES:

- Perfect system for large areas
- Suitable for both traditional and liquid screeds
- CAD Heating design provided for installers
- Easy one person installation
- Maximum thermal mass for heating
- The ultimate underfloor heating system

SCAN HERE

TO SEE DATA SHEETS  
FOR PRODUCTS  
ON THIS PAGE



## CASTELLATED PANELS

### TYPICAL FLOOR PROFILE

#### CASTELLATED

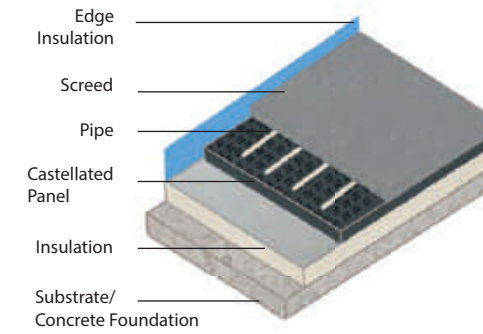

#### FAST FIX

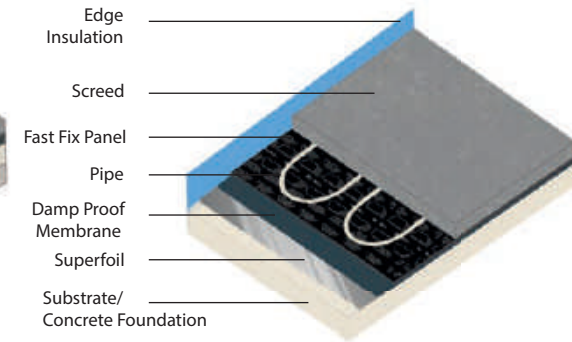

| PRODUCT                                | SIZE (mm)       | PIPE | CODE      |
|--|-----------------|------|-----------|
| LOWtek castellated adhesive panel      | 1050 x 650 x 15 | 12mm | RHS30-001 |
| Low profile FastFix panel              | 600 x 600 x 15  | 12mm | RHS30-006 |
| 20mm castellated panel (film only)     | 1250 x 850 x 20 | 16mm | RHS30-007 |
| 20mm castellated panel (film/adhesive) | 1250 x 850 x 20 | 16mm | RHS30-008 |
| 20mm castellated panel (film only)     | 1450 x 950 x 20 | 16mm | RHS30-002 |
| 20mm castellated panel 10mm EPS        | 1450 x 950 x 30 | 16mm | RHS30-003 |
| 20mm castellated panel 30mm EPS        | 1450 x 950 x 50 | 16mm | RHS30-004 |
| Octopro castellated panel (adhesive)   | 600 x 600 x 20  | 16mm | RHS30-009 |



#### KEY FEATURES:

- Low and Ultra low profile systems
- Options for 12mm and 16mm pipe
- Suitable for new build and retrofit
- Excellent performance with high heat output at low flow temperatures
- Lightweight for quick and easy installation
- Pipe centres in multiples of 50mm

SCAN HERE

TO SEE DATA SHEETS  
FOR PRODUCTS  
ON THIS PAGE



# OVERLAY SYSTEMS

## LOW PROFILE BOARDS

### TYPICAL FLOOR PROFILE

#### SCREEDBOARD

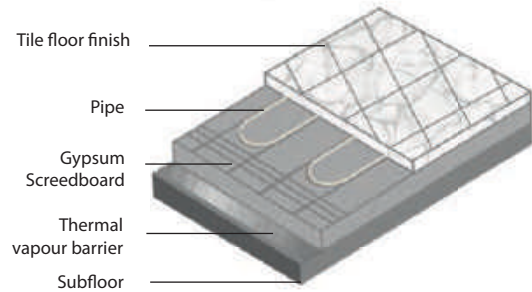

#### CEMENT FACED BOARD

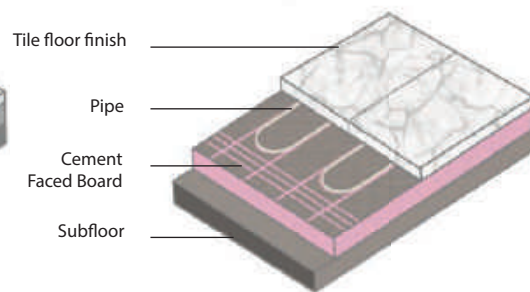

| PRODUCT                          | SIZE (mm)       | PIPE | CODE      |
|----------------------------------|-----------------|------|-----------|
| Multi Directional Screedboard    | 1200 x 600 x 18 | 12mm | RHS33-007 |
| Cement Faced Board               | 1200 x 600 x 20 | 12mm | RHS32-014 |
| Cement Faced Board               | 1200 x 600 x 20 | 16mm | RHS32-016 |
| Superfoil Thermal Vapour Barrier | 1500 x 25m      |      | RHS34-003 |



#### SCREEDBOARD KEY FEATURES:

- Manufactured from reinforced gypsum
- High Impact resistance
- Super low profile at just 18mm thickness
- High thermal conductivity
- Due to dry installation, final floor finishes can be installed immediately
- 150mm pipe centres with 12mm pipe

#### CEMENT FACED KEY FEATURES:

- High compressive strength 400 kPa
- Low profile just 20mm high
- 0.72m<sup>2</sup> area per board
- Accepts direct tiling
- Made to suit either 12mm or 16mm diameter pipes
- Lightweight and easy to install
- 150mm pipe centres

### TYPICAL FLOOR PROFILE

#### XPS

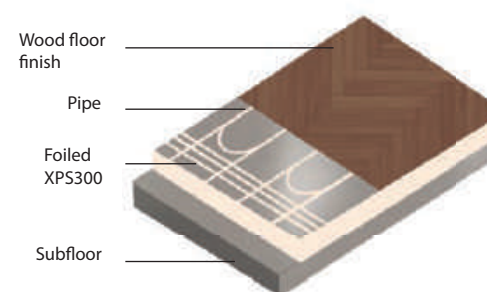

#### EPS

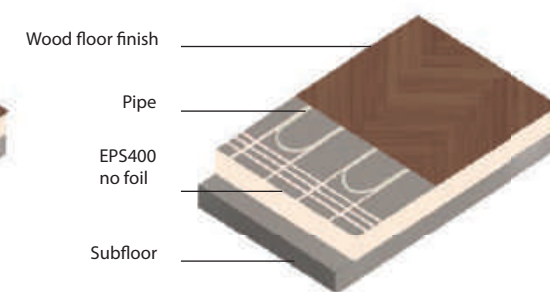

| PRODUCT                 | PIPE | CENTRES | CODE      |
|-------------------------|------|---------|-----------|
| XPS300 x 18mm - FOILED  | 12mm | 150mm   | RHS32-005 |
| XPS300 x 18mm - NO FOIL | 12mm | 150mm   | RHS32-022 |
| XPS300 x 20mm - FOILED  | 16mm | 150mm   | RHS32-009 |
| XPS300 x 20mm - FOILED  | 16mm | 200mm   | RHS32-004 |
| XPS300 x 25mm - NO FOIL | 16mm | 150mm   | RHS32-021 |
| XPS400 x 20mm - FOILED  | 16mm | 150mm   | RHS32-019 |
| EPS400 x 16mm - FOILED  | 12mm | 150mm   | RHS32-024 |
| EPS400 x 16mm - NO FOIL | 12mm | 150mm   | RHS32-025 |
| EPS400 x 20mm - FOILED  | 16mm | 150mm   | RHS32-027 |
| EPS400 x 20mm - NO FOIL | 16mm | 150mm   | RHS32-026 |
| EPS400 x 20mm - FOILED  | 16mm | 200mm   | RHS32-028 |
| EPS400 x 25mm - FOILED  | 16mm | 150mm   | RHS32-029 |
| EPS400 x 25mm - FOILED  | 16mm | 200mm   | RHS32-030 |

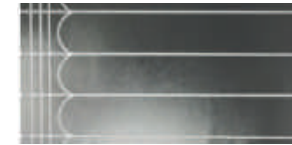

Made to measure routed panels to fit between joists and bespoke size panels are available on request.



#### KEY FEATURES:

- Low profile retrofit system for 16mm and 12mm pipe
- Extremely cost effective solution
- Can be used under screeds, chipboard, in heated slabs and below suspended slabs.
- Lightweight and easy to install- no specialist equipment needed
- Maintains its thermal efficiency

## ALUMINIUM DIFFUSER PLATES

### TYPICAL FLOOR PROFILE

#### FIT FROM ABOVE (FFA)

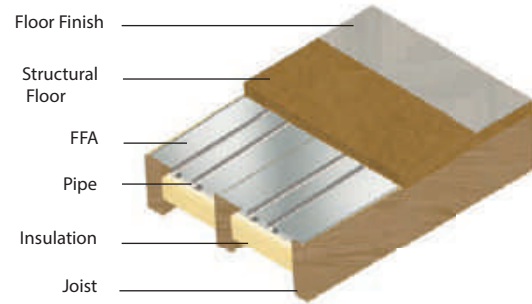

#### FIT FROM BELOW (FFB)

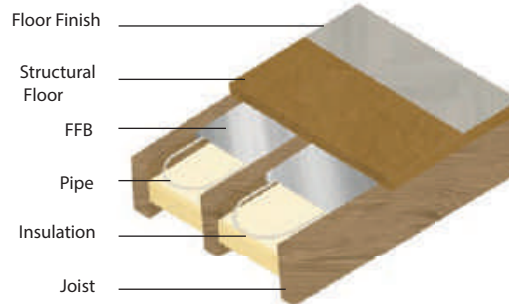

| PRODUCT                    | SIZE (mm)  | PIPE | CENTRES | CODE      |
|----------------------------|------------|------|---------|-----------|
| Double channel FFA         | 390 x 1000 | 16mm | 200mm   | RHS31-001 |
| Triple channel FFA         | 390 x 1000 | 16mm | 150mm   | RHS31-002 |
| Triple channel FFA         | 590 x 1000 | 16mm | 200mm   | RHS31-003 |
| Double channel FFB         | 150 x 1000 | 16mm | 150mm   | RHS31-004 |
| Double channel FFB         | 200 x 1000 | 16mm | 200mm   | RHS31-005 |
| Double channel FFB         | 250 x 1000 | 16mm | 250mm   | RHS31-006 |
| Single channel J Plate FFB | 180 x 1000 | 16mm | 16mm    | RHS31-007 |

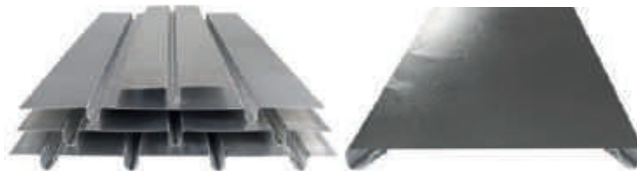

#### KEY FEATURES:

- Zero height build up
- Ideal for all room sizes, single or multi room
- Between joist system
- Options to install from above or below finished floor
- Aluminium plate diffuses heat across panel
- Options for double or triple pipe runs



## TONGUE AND GROOVE BOARDS

### TYPICAL FLOOR PROFILE

#### TONGUE AND GROOVE WITH FOIL

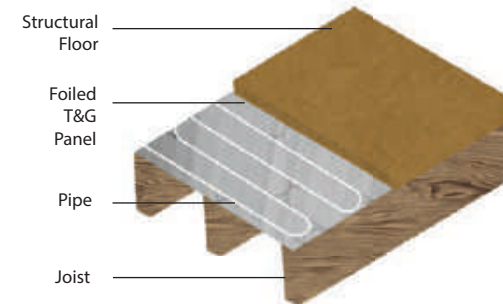

#### TONGUE AND GROOVE WITHOUT FOIL

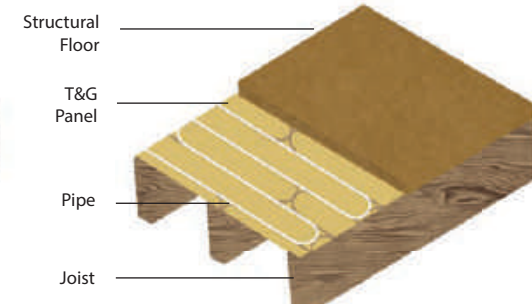

| PRODUCT                | SIZE (mm)       | PIPE | CENTRES | CODE      |
|------------------------|-----------------|------|---------|-----------|
| Foiled T&G Board 22mm  | 2400 x 600 x 22 | 12mm | 150mm   | RHS32-015 |
| No foil T&G Board 22mm | 2400 x 600 x 22 | 12mm | 150mm   | RHS32-020 |

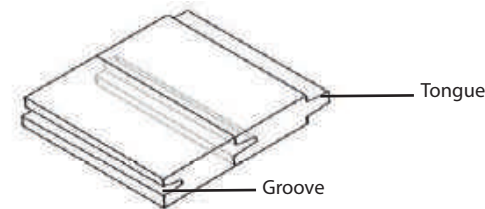

#### KEY FEATURES:

- Low floor build up
- Tongue and groove system for integrated installation
- Install with standard chipboard screws and joint adhesive
- Available with or without foil
- Requires a minimum of 6mm ply over top to make structural finish

## STAINLESS STEEL MANIFOLDS

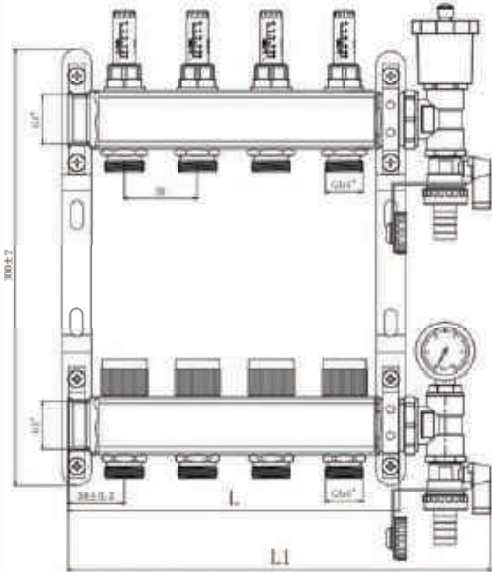

| PORTS | WIDTH L (mm) | WIDTH L1 (mm) | CODE      |
|-------|--------------|---------------|-----------|
| 2     | 126          | 188           | RHS80-002 |
| 3     | 176          | 238           | RHS80-003 |
| 4     | 226          | 288           | RHS80-004 |
| 5     | 276          | 338           | RHS80-005 |
| 6     | 326          | 388           | RHS80-006 |
| 7     | 376          | 438           | RHS80-007 |
| 8     | 426          | 488           | RHS80-008 |
| 9     | 476          | 538           | RHS80-009 |
| 10    | 526          | 588           | RHS80-010 |
| 11    | 576          | 638           | RHS80-011 |
| 12    | 626          | 688           | RHS80-012 |

Pressure gauge and auto air vent included.

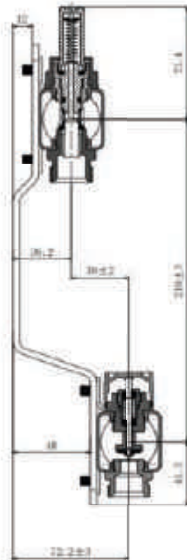

## MANIFOLD CONTROL PACKS AND PUMPS

### PRODUCT

Manifold control pack with pump and blending valve  
 Manifold control pack with pump, no blending valve (for Heat Pump systems)

### CODE

RHS10-008  
 RHS81-002

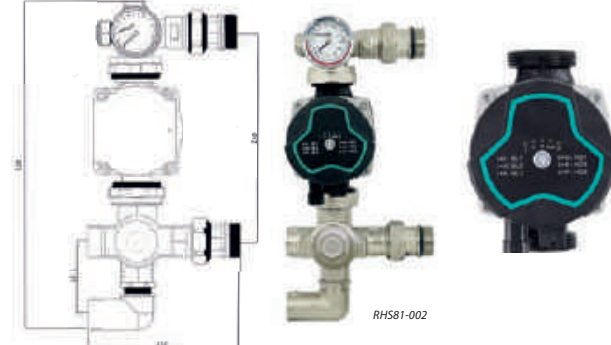
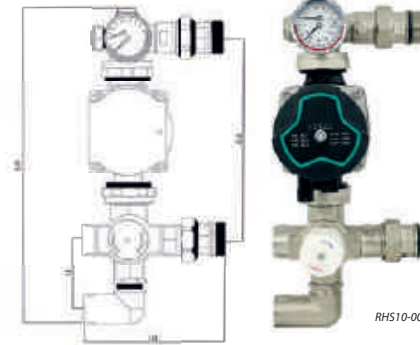

Manifold control blending valve pack (no pump)  
 Base Pump (A Rated with 7.5m head & cable)  
 Wilo Pump (A rated with 6m head & cable)  
 Wilo Pump (A rated with 8m head & cable)  
 Wilo Pump (A rated with 9m head & cable)  
 Grundfos Pump (A rated with 7m head & cable)

RHS81-001  
 RHS81-007  
 RHS81-004  
 RHS81-005  
 RHS81-006  
 RHS10-004

## SINGLE ROOM KITS

Designed for use on small rooms or extensions, provides temperature controlled mixed water to underfloor heating systems with a heat output of up to 3kW, satisfying underfloor heating areas up to 40sqm.

### PRODUCT

Single room control pack (pump supplied separately)  
 20m<sup>2</sup> room kit\*  
 30m<sup>2</sup> room kit\*  
 40m<sup>2</sup> room kit\*  
 40m<sup>2</sup> wireless room kit\*\*

### CODE

RHS81-003  
 RHS85-001  
 RHS85-002  
 RHS85-003  
 RHS85-004

\*includes relevant pipe, thermostat, clips, euroconus, manifold.

\*\* As above and also includes wireless receiver.

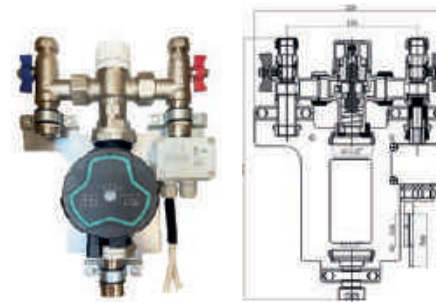

**SCAN HERE**  
 TO SEE DATA SHEETS FOR MANIFOLDS

**SCAN HERE**  
 TO SEE DATA SHEETS

## HEATMISER THERMOSTATS

### DS-SB Series

Dial thermostat



RHS40-003

### Slimline- RF

Wireless, programmable 230v



Thermostat Only RHS40-015  
Thermostat and Receiver RHS40-016

### Slimline

Programmable 230v thermostat



RHS40-004

### NeoHub - Internet Gateway

Essential for app control of heating and hot water.



RHS44-006



### Wiring Centres

4 way RHS41-001  
6 way RHS41-002  
8 way RHS41-003  
8 way RF RHS41-004  
UH8-N 12v RHS41-005



### NeoStat

230v. Timer or Heating Mode. Compatible with remote sensors



RHS40-019

### NeoAir Wireless

App controlled thermostat to pair with NeoHub



RHS40-021

### NeoStat WiFi

230v thermostat that operates directly with router without gateway.



White RHS40-026  
Carbon RHS40-027

### NeoStat 12v

Compatible with UH8-N 12v wiring centre.



RHS40-020

### Accessories

Sensor probe RHS44-001  
RF receiver RHS44-005  
Thimble sensor RHS44-009  
Sensor box RHS44-003  
NeoPlug RHS44-010  
NeoAir stand RHS44-011  
Wireless Sensor RHS44-022

## RWC THERMOSTATS



### Thermostats

240v wired Black  
240v wired White  
240v Wired/RF Black  
240v Wired/RF White  
RF Wireless Black  
RF Wireless White

RHS47-001  
RHS47-002  
RHS47-003  
RHS47-004  
RHS47-005  
RHS47-006

### Accessories

Hot water timer Black  
Hot water timer White  
Sensor probe NTC10K  
Sensor probe NTC100K  
Sensor housing  
240v wiring centre  
240v wiring centre RF  
Internet gateway RF

RHS44-027  
RHS44-028  
RHS44-024  
RHS44-025  
RHS44-026  
RHS48-001  
RHS48-002  
RHS44-023



## OTHER THERMOSTATS



### Thermostats

Radical 230v Touch Screen Digital Stat  
Radical 230v 8 Way Wiring centre  
Radical Floor probe 10k

RHS88-001  
RHS88-002  
RHS88-003

230v Smart WiFi Stat black  
230v Smart WiFi Stat white  
24v Smart WiFi Stat white

RHS88-010  
RHS88-011  
RHS88-012

230v On Wall Dial Stat  
230v On Wall Dial with floor sensor white  
230v Tamper Proof Dial Stat white

RHS88-004  
RHS88-005  
RHS88-006

RF WiFi Stat white + single receiver  
RF Smart WiFi Stat black  
RF Smart Wifi Stat white

RHS88-013  
RHS88-014  
RHS88-015

230v 7 Day Programmable Stat black  
230v 7 Day Programmable Stat white  
24v 7 Day Programmable Stat white

RHS88-007  
RHS88-008  
RHS88-009

230v 8 Way wiring centre  
RF wireless wiring centre  
Gateway hub for smart controls  
10k floor sensor probe

RHS88-016  
RHS88-017  
RHS88-018  
RHS88-019

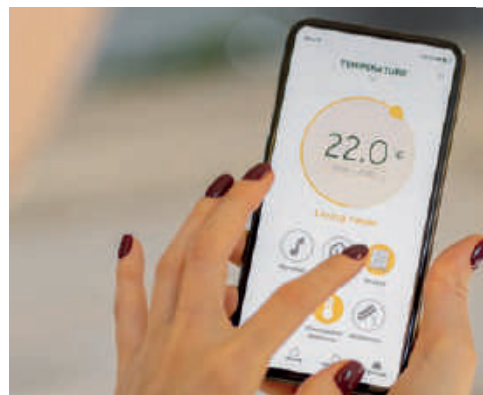



# COMPONENTS AND TOOLS

## 230v ACTUATOR

230v normally closed electrothermic actuator

RHS84-007



## CLIP RAIL

1m self adhesive RHS54-003  
1m barbed RHS54-004



## AUTO AIR VENT

1/2"MBSP RHS50-001



## CONDUIT

19mm-23mm, 50m length

RHS53-001



## BALL VALVE (PAIR)

For connection/isolation of manifold to circulating pump

Male to Female RHS84-004  
Female to female RHS84-005



## EDGE INSULATION

Tape Adhesive RHS53-003  
Double Adhesive RHS53-004



## BLANKING CAP

Used to restrict and stop flow of water on manifold ports.

3/4" FBSP RHS84-003



## EXTENSION KIT

Male to female SP.

RHS50-009



## BLENDING VALVE

22mm RHS50-010  
28mm RHS50-011



## EUROCONES (3/4 THREAD)

12mm x 2mm RHS84-001  
16mm x 2mm RHS84-002  
12mm x 1.6mm RHS84-006



## CLIPS

43mm RHS54-007  
60mm RHS54-006



## FOIL INSULATION

RHS34-003



## MONOBLOCCO (METRIC THREAD)

12mm RHS51-005  
16mm RHS51-006



## PIPE REAMERS AND CHAMFERS

Small Star Reamer 12/16/20mm RHS55-006  
Large Star Reamer 16/20/25mm RHS55-007  
Chamfering device for 16mm MLCP RHS55-008

## PIPE BEND SUPPORT

14-18mm RHS53-002



## PIPE CUTTERS

Small 14-32mm RHS55-004  
Large 42mm RHS55-005



## PIPE JOINT CONNECTIONS

12mm RHS51-007  
16mm RHS51-008  
Tee RHS51-009  
Elbow RHS51-003



## PRESSURE GAUGE

Includes adaptor

1/2"FBSP RHS50-003



## PRESSURE TEST PUMP

RHS55-009



## OVERHEAT THERMOSTAT

1/4"MBSP RHS44-012



## ELECTRIC HYDRAULIC CLAMP SET

For Pressfit. Includes 16,20,25,32mm head, 2 batteries and charger.

RHS55-003



## ZONE VALVES

22mm RHS52-001  
28mm RHS52-002



SCAN HERE

FOR DATA SHEETS AND FULL RANGE OF COMPONENTS

## EQUAL STRAIGHT UNION

| SIZE                | QTY | CODE      |
|---------------------|-----|-----------|
| 16 x 16             | 40  | RHS90-001 |
| 20 x 20             | 28  | RHS90-002 |
| 25 x 25             | 12  | RHS90-003 |
| 32 x 32             | 10  | RHS90-004 |
| 20 x 2.25-20 x 2.25 | 28  | RHS90-053 |

## MALE STRAIGHT UNION

| SIZE           | QTY | CODE      |
|----------------|-----|-----------|
| 16 x 1/2M      | 40  | RHS90-011 |
| 16 x 3/4M      | 25  | RHS90-012 |
| 20 x 1/2M      | 25  | RHS90-070 |
| 20 x 3/4M      | 25  | RHS90-013 |
| 25 x 1/2M      | 15  | RHS90-014 |
| 25 x 3/4M      | 15  | RHS90-015 |
| 25 x 1M        | 15  | RHS90-016 |
| 32 x 3/4M      | 12  | RHS90-017 |
| 32 x 1M        | 12  | RHS90-018 |
| 20 x 2.25-3/4M | 25  | RHS90-057 |

## FEMALE STRAIGHT UNION

| SIZE      | QTY | CODE      |
|-----------|-----|-----------|
| 16 x 1/2F | 35  | RHS90-019 |
| 16 x 3/4F | 30  | RHS90-020 |
| 20 x 1/2F | 20  | RHS90-071 |
| 20 x 3/4F | 20  | RHS90-021 |
| 25 x 3/4F | 15  | RHS90-022 |
| 25 x 1F   | 12  | RHS90-023 |
| 32 x 3/4F | 12  | RHS90-024 |
| 32 x 1F   | 12  | RHS90-025 |

## UNEQUAL STRAIGHT UNION

| SIZE           | QTY | CODE      |
|----------------|-----|-----------|
| 20x16          | 30  | RHS90-005 |
| 25x16          | 15  | RHS90-006 |
| 25x20          | 12  | RHS90-007 |
| 32x16          | 10  | RHS90-008 |
| 32x20          | 10  | RHS90-009 |
| 32x25          | 10  | RHS90-010 |
| 20x2.25-16x2   | 30  | RHS90-054 |
| 25x2.5-20x2.25 | 12  | RHS90-055 |
| 32x3-20x2.25   | 10  | RHS90-056 |

## EQUAL ELBOW

| SIZE                 | QTY | CODE      |
|----------------------|-----|-----------|
| 16 x 16              | 24  | RHS90-026 |
| 20 x 20              | 18  | RHS90-027 |
| 25 x 25              | 9   | RHS90-028 |
| 32 x 32              | 6   | RHS90-029 |
| 20 x 2.25 to 20x2.25 | 18  | RHS90-058 |

## ELBOW WITH PLATE

| SIZE             | QTY | CODE      |
|------------------|-----|-----------|
| 16 x 1/2F female | 10  | RHS90-040 |
| 16 x 3/4F female | 10  | RHS90-041 |
| 20 x 1/2F female | 10  | RHS90-094 |
| 20 x 3/4F female | 10  | RHS90-095 |
| 16 x 1/2M male   | 10  | RHS90-050 |
| 16 x 3/4M male   | 10  | RHS90-051 |
| 20 x 3/4M male   | 10  | RHS90-093 |

## FEMALE ELBOW

| SIZE      | QTY | CODE      |
|-----------|-----|-----------|
| 16 x 1/2F | 20  | RHS90-076 |
| 16 x 3/4F | 15  | RHS90-077 |
| 20 x 1/2F | 18  | RHS90-078 |
| 20 x 3/4F | 15  | RHS90-079 |
| 25 x 1F   | 8   | RHS90-080 |
| 25 x 3/4F | 15  | RHS90-081 |
| 32 x 1F   | 6   | RHS90-082 |

## MALE ELBOW

| SIZE      | QTY | CODE      |
|-----------|-----|-----------|
| 16 x 1/2M | 24  | RHS90-083 |
| 20 x 1/2M | 24  | RHS90-084 |
| 20 x 3/4M | 15  | RHS90-085 |
| 25 x 3/4M | 10  | RHS90-086 |
| 32 x 1M   | 6   | RHS90-087 |

## SWIVEL ELBOW

| SIZE             | QTY | CODE      |
|------------------|-----|-----------|
| 16 x 1/2F female | 24  | RHS90-088 |
| 20 x 3/4F female | 15  | RHS90-089 |

## UNEQUAL TEE

| SIZE                       | QTY | CODE      |
|----------------------------|-----|-----------|
| 20 x 16 x 16               | 12  | RHS90-034 |
| 25 x 16 x 25               | 6   | RHS90-035 |
| 32 x 16 x 32               | 6   | RHS90-036 |
| 32 x 25 x 32               | 3   | RHS90-037 |
| 16 x 20 x 16               | 12  | RHS90-038 |
| 20 x 20 x 16               | 12  | RHS90-039 |
| 20 x 2.25-16 x 2-16 x 2    | 12  | RHS90-060 |
| 20 x 2.25-20 x 2.25-16 x 2 | 12  | RHS90-061 |
| 20 x 16 x 20               | 12  | RHS90-065 |
| 25 x 20 x 25               | 6   | RHS90-066 |
| 25 x 16 x 16               | 6   | RHS90-067 |
| 25 x 20 x 20               | 6   | RHS90-068 |
| 32 x 25 x 25               | 3   | RHS90-069 |
| 25 x 25 x 16               | 6   | RHS90-090 |
| 32 x 20 x 32               | 3   | RHS90-091 |

## EQUAL TEE

| SIZE                    | QTY | CODE      |
|-------------------------|-----|-----------|
| 16x16x16                | 15  | RHS90-030 |
| 20x20x20                | 12  | RHS90-031 |
| 25x25x25                | 6   | RHS90-032 |
| 32x32x32                | 3   | RHS90-033 |
| 20x2.25-20x2.25-20x2.25 | 12  | RHS90-059 |

## EXTRAS

|   |           |
|---|-----------|
| 16mm Radiator Elbow w/<br>300mm chrome pipe | RHS90-049 |
| Connector OEM 20x2.25 to 20x2               | RHS90-052 |

## FEMALE TEE

| SIZE           | QTY | CODE      |
|----------------|-----|-----------|
| 25 x 1/2F x 25 | 6   | RHS90-092 |

## SWIVEL COUPLE

| SIZE     | QTY | CODE      |
|----------|-----|-----------|
| 16 x 1/2 | 40  | RHS90-072 |
| 20 x 1/2 | 20  | RHS90-073 |
| 20 x 3/4 | 15  | RHS90-074 |
| 25 x 3/4 | 30  | RHS90-075 |

## COPPER ADAPTER

| SIZE             | QTY | CODE      |
|------------------|-----|-----------|
| 16-15mm tail     | 45  | RHS90-045 |
| 20-15mm tail     | 28  | RHS90-046 |
| 20-22mm tail     | 18  | RHS90-047 |
| 25-22mm tail     | 12  | RHS90-048 |
| 20 x 2.25 - 15mm | 28  | RHS90-063 |
| 20 x 2.25 - 22mm | 18  | RHS90-064 |
| 25 - 28mm tail   | 10  | RHS90-096 |
| 32 x 28mm tail   | 8   | RHS90-097 |

## END CAP

| SIZE      | QTY | CODE      |
|-----------|-----|-----------|
| 16mm      | 60  | RHS90-042 |
| 20mm      | 40  | RHS90-043 |
| 25mm      | 25  | RHS90-044 |
| 20x2.25mm | 40  | RHS90-062 |



**SCAN HERE**

FOR PRESSFIT DATA SHEETS



## SELF ADHESIVE MESH MATS 150w per m<sup>2</sup> 0.5m wide



| SIZE              | CODE      | SIZE              | CODE      | SIZE               | CODE      |
|-------------------|-----------|-------------------|-----------|--------------------|-----------|
| 1.0m <sup>2</sup> | RHS62-001 | 3.5m <sup>2</sup> | RHS62-006 | 7.0m <sup>2</sup>  | RHS62-011 |
| 1.5m <sup>2</sup> | RHS62-002 | 4.0m <sup>2</sup> | RHS62-007 | 8.0m <sup>2</sup>  | RHS62-012 |
| 2.0m <sup>2</sup> | RHS62-003 | 4.5m <sup>2</sup> | RHS62-008 | 9.0m <sup>2</sup>  | RHS62-013 |
| 2.5m <sup>2</sup> | RHS62-004 | 5.0m <sup>2</sup> | RHS62-009 | 10.0m <sup>2</sup> | RHS62-014 |
| 3.0m <sup>2</sup> | RHS62-005 | 6.0m <sup>2</sup> | RHS62-010 | 12.0m <sup>2</sup> | RHS62-015 |

## ALUMINIUM FOIL MATS 150w per m<sup>2</sup> 0.5m wide



| SIZE              | CODE      | SIZE              | CODE      | SIZE               | CODE      |
|-------------------|-----------|-------------------|-----------|--------------------|-----------|
| 1.0m <sup>2</sup> | RHS61-001 | 3.5m <sup>2</sup> | RHS61-006 | 7.0m <sup>2</sup>  | RHS61-011 |
| 1.5m <sup>2</sup> | RHS61-002 | 4.0m <sup>2</sup> | RHS61-007 | 8.0m <sup>2</sup>  | RHS61-012 |
| 2.0m <sup>2</sup> | RHS61-003 | 4.5m <sup>2</sup> | RHS61-008 | 9.0m <sup>2</sup>  | RHS61-013 |
| 2.5m <sup>2</sup> | RHS61-004 | 5.0m <sup>2</sup> | RHS61-009 | 10.0m <sup>2</sup> | RHS61-014 |
| 3.0m <sup>2</sup> | RHS61-005 | 6.0m <sup>2</sup> | RHS61-010 | 12.0m <sup>2</sup> | RHS61-015 |

## LOOSE CABLE 12w per m



| SIZE   | CODE      | SIZE   | CODE      | SIZE   | CODE      |
|--------|-----------|--------|-----------|--------|-----------|
| 12.5m  | RHS60-001 | 43.75m | RHS60-006 | 87.5m  | RHS60-011 |
| 18.75m | RHS60-002 | 50.0m  | RHS60-007 | 100m   | RHS60-012 |
| 25.0m  | RHS60-003 | 56.25m | RHS60-008 | 112.5m | RHS60-013 |
| 31.25m | RHS60-004 | 62.5m  | RHS60-009 | 125m   | RHS60-014 |
| 37.5m  | RHS60-005 | 75.0m  | RHS60-010 | 150m   | RHS60-015 |

Decoupling carrier mat (price per m<sup>2</sup>) RHS60-016

## ELECTRIC ACCESSORIES

### PRODUCT

|                                       |           |
|---------------------------------------|-----------|
| Dial & switch thermostat white        | RHS63-001 |
| Heatmiser slimline-e thermostat white | RHS63-002 |
| Heatmiser touch-e thermostat carbon   | RHS63-003 |
| Heatmiser touch-e thermostat white    | RHS63-004 |
| Heatmiser Neostat-e white             | RHS63-005 |

Electric Underfloor programmable white  
Electric Underfloor Smart Wifi white



## HEAT PUMPS

Our range of domestic Air Source Heat Pumps from the world's largest HVAC manufacturers offer assured performance and are fully MCS certified and RECC warrantied.

Our specialised team are here to assist with each step of the heat pump installation process. From heating system design and technical assessment, heat pump cylinder selection, guidance and assistance on UK Government incentives to final commissioning.

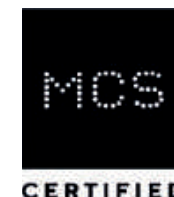

### Benefits:

- Qualifies for UK Government incentives and schemes including 0% VAT on heat pump
- A++++ high efficiency system
- Low to zero carbon solution
- Reduced energy bill costs
- Ideal for both new build and retro fit projects
- Perfect heat source for underfloor heating systems
- Simple installation process
- Whisper quiet
- Excellent track record and trusted performance
- Future proof heating system
- Full range of compatible DHW Cylinders also available.



# HOW TO GET A QUOTE

## QUOTATION REQUIREMENTS

Please send your drawings to [sales@rhsltd.co.uk](mailto:sales@rhsltd.co.uk)

Please include:

- Floor Construction
- Heat Source - Gas Boiler, Heat Pump, LPG, Oil or other
- Thermostat type
- Rooms to be heated
- Manifold Location
- Final floor covering

## HOW TO PLACE YOUR ORDER

Please send an email with your purchase order to [sales@rhsltd.co.uk](mailto:sales@rhsltd.co.uk).

Make sure to include:

- Quotation number (if applicable)
- Confirm if a CAD drawing is required
- Confirm delivery address and date required
- Advise of any vehicle restrictions for access

Please carefully check your purchase order before sending to ensure your details and required products are correct.

## CONTACT US

EMAIL: [sales@rhsltd.co.uk](mailto:sales@rhsltd.co.uk)

TEL: 0161 711 0612

[www.rhsltd.co.uk](http://www.rhsltd.co.uk)

Unit 7, Chorley Central Business Park, Chorley, Lancashire PR6 0BL

## SCAN TO VISIT OUR WEBSITE:



### TERMS AND CONDITIONS

Radical Heating Solutions Ltd use third party couriers and therefore delivery times and dates cannot be guaranteed. Radical Heating Solutions Ltd cannot be held responsible or accept claims for any consequential loss as a result of failed/late deliveries.

**RADICAL**

HEATING SOLUTIONS LTD  
[WWW.RHSLTD.CO.UK](http://WWW.RHSLTD.CO.UK)

**0161 711 0612**

[SALES@RHSLTD.CO.UK](mailto:SALES@RHSLTD.CO.UK)